

⚡ Specifications

Nominal Voltage(V)

12V

Nominal Capacity

20 hour rate	(0.6A to 10.50V)	12Ah
10 hour rate	(1.14A to 10.50V)	11.4Ah
5 hour rate	(2.04A to 10.20V)	10.2Ah
1 C	(12A to 9.60V)	6.8Ah
3 C	(36A to 9.60V)	4.8Ah

Weight

Approx. 4.02kg(8.84Lbs.)

Internal Resistance (at 1KHz)

Approx. 11 mΩ

Maximum Discharge Current for

5 seconds: 180A

Charging Methods at 25°C(77°F)

Cycle use:	
Charging Voltage	14.4 to 15.0V
Coefficient -5.0mV/°C/cell	
Maximum Charging Current :	3.6A
Standby use:	
Float Charging Voltage	13.5 to 13.8V
Coefficient -3.0mV/°C/cell	

Operating Temperature Range

Charge	-15°C(5°F)	to	40°C(104°F)
Discharge	-15°C(5°F)	to	50°C(122°F)
Storage	-15°C(5°F)	to	40°C(104°F)

Charge Retention (shelf life) at 20°C(68°F)

1 month	92%
3 month	90%
6 month	80%

Case Material

ABS UL94 HB
Option: Flammability resistance of (UL94 V-0)

Design Life

3-5 Years.

Terminal

F1 or F2 (Faston Tab 187 or 250)

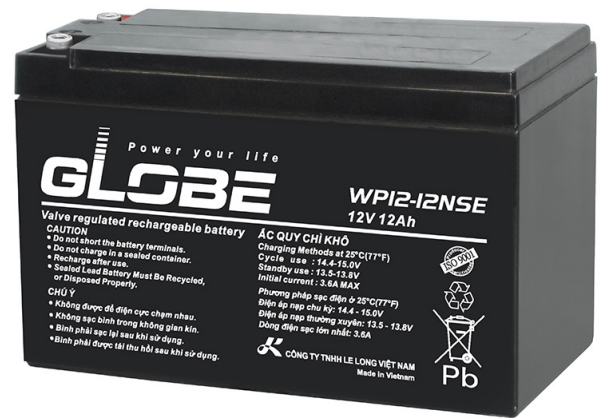

⚡ Dimensions

Length (L)	151±1 (5.94±0.04)
Width (W)	98±1 (3.86±0.04)
Height (H)	93±1 (3.66±0.04)
Overall Height (HT)	94±1 (3.70±0.04)

mm(inch)

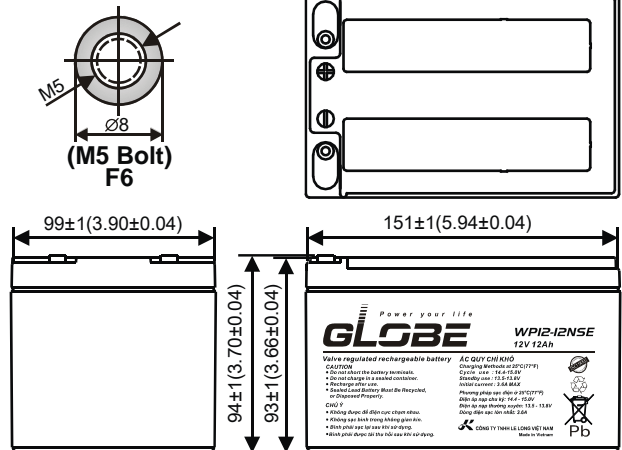

(V) Discharge Time VS. Discharge Current (25°C)

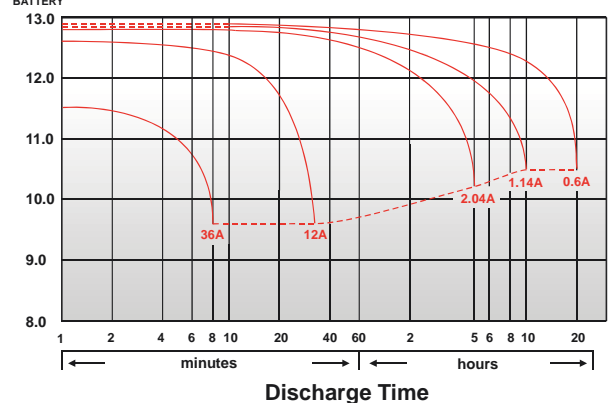

Effect of Temperature on Capacity 25°C (77°F)

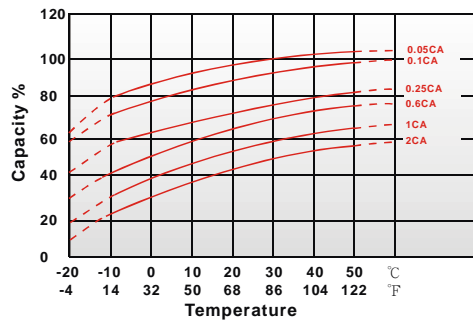

Capacity Retention Characteristic

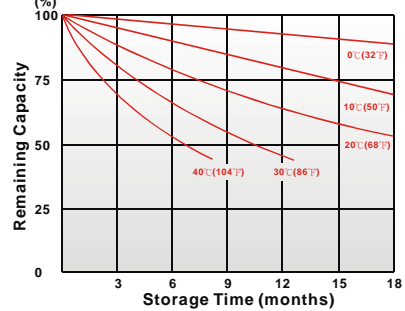

Cycle Service Life

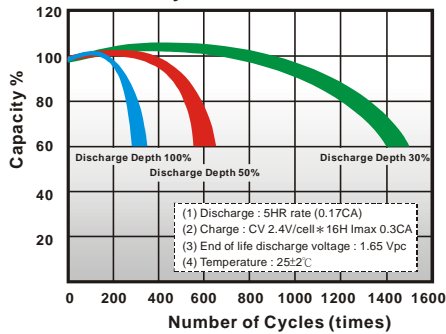

Trickle (or float) Service Life

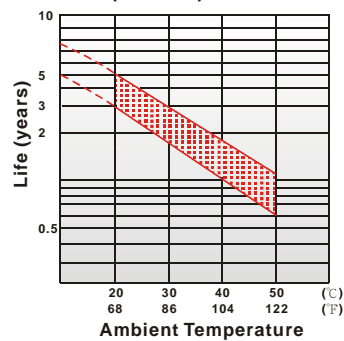

- PERFORMANCE DATA

Discharge Rates in Watts to Various End Voltages at 25°C (77°F)

End Voltage		1.85V	1.80V	1.75V	1.70V	1.67V	1.65V	1.60V
Time								
5	min	77.2	84.2	89.3	94.8	97.3	99.7	105
10	min	56.5	60.3	63.0	65.3	66.2	67.5	68.8
15	min	42.2	45.3	47.2	48.5	49.2	49.8	51.0
30	min	26.7	28.0	29.0	30.0	30.3	30.7	31.2
60	min	14.9	15.9	16.6	17.2	17.3	17.5	17.7
120	min	7.80	8.60	9.02	9.22	9.28	9.38	9.52
180	min	5.40	6.15	6.53	6.68	6.97	7.10	7.20
240	min	4.43	4.97	5.22	5.37	5.43	5.52	5.62
300	min	4.12	4.35	4.51	4.65	4.72	4.77	4.83
600	min	2.43	2.55	2.62	2.66	2.68	2.70	2.72
1200	min	1.29	1.31	1.35	1.37	1.39	1.40	1.43

- Discharge Rates in Amperes to Various End Voltages at 25°C (77°F)

End Voltage		1.85V	1.80V	1.75V	1.70V	1.67V	1.65V	1.60V
Time								
5	min	37.8	41.8	44.6	47.5	48.8	50.1	52.7
10	min	28.1	30.3	31.5	32.7	33.2	33.8	34.6
15	min	21.3	22.6	23.7	24.6	25.0	25.4	26.1
30	min	12.6	13.5	14.1	14.6	14.8	15.0	15.3
60	min	8.55	8.74	8.86	8.97	9.02	9.08	9.16
120	min	4.71	4.84	4.95	5.04	5.08	5.13	5.18
180	min	3.14	3.33	3.40	3.46	3.49	3.52	3.56
240	min	2.15	2.26	2.35	2.42	2.45	2.49	2.74
300	min	1.98	2.06	2.12	2.18	2.20	2.23	2.27
600	min	1.19	1.22	1.24	1.26	1.27	1.28	1.29
1200	min	0.619	0.626	0.645	0.654	0.661	0.669	0.683

All data on the spec. sheet is an average value:

The tolerance range : $X < 6\text{min}$ (+15%~-15%), $6\text{min} \leq X < 10\text{min}$ (+12%~-12%), $10\text{min} \leq X < 60\text{min}$ (+8%~-8%), $X \geq 60\text{min}$ (+5%~-5%)

140422-1A-V